

3 611 B67 100

Issue } 14-03-27  
Stand }

**Fig./Abb. 2**

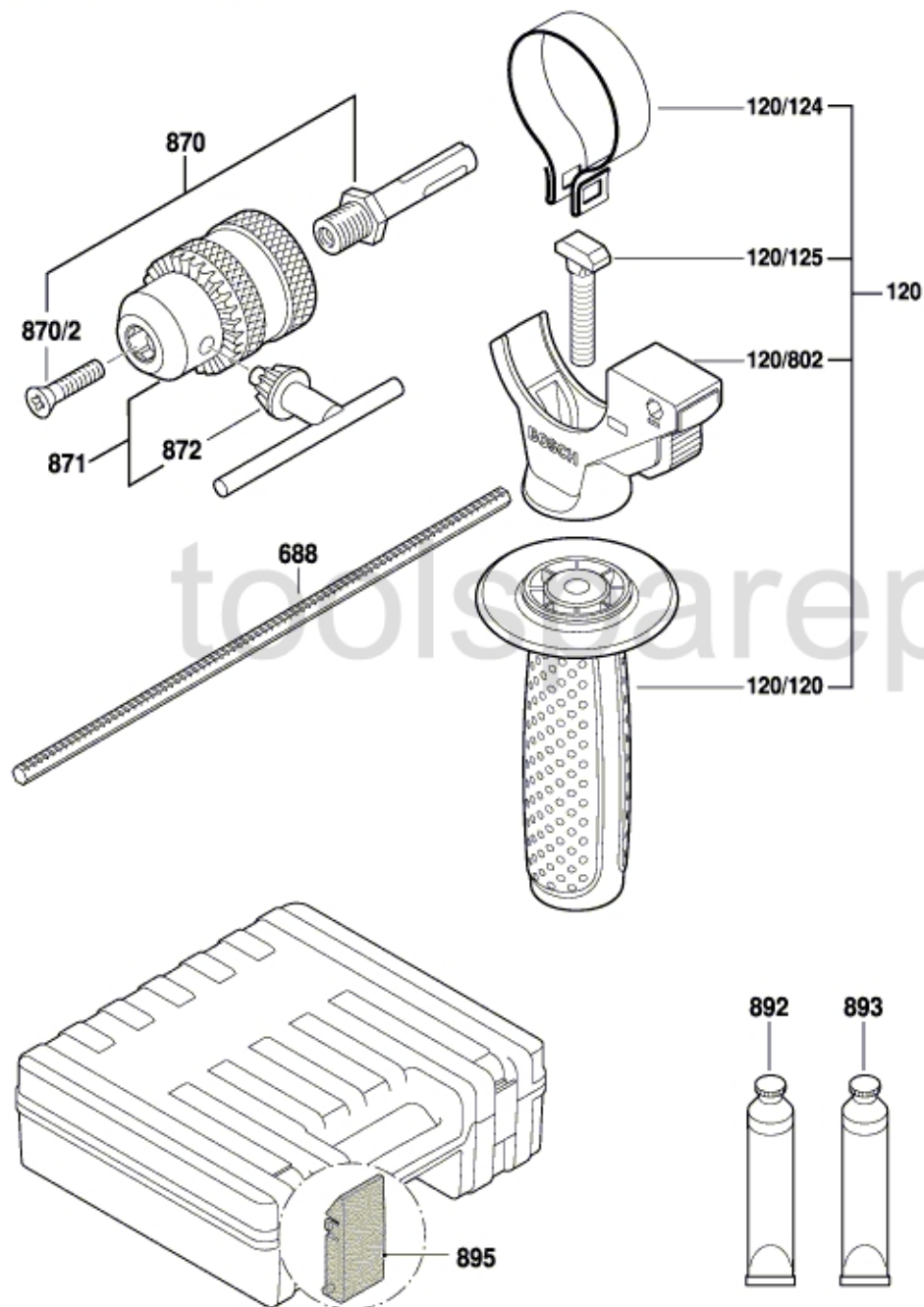

Modifications reserved  
Änderungen vorbehalten  
Modifications réservées  
Salvo modificaciones